

SERVICE MANUAL

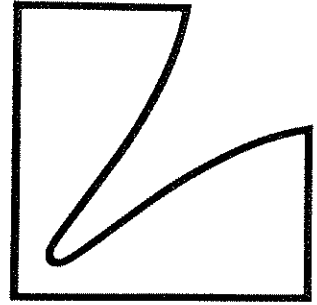

LUXMAN
STEREO CASSETTE DECK **K-8**

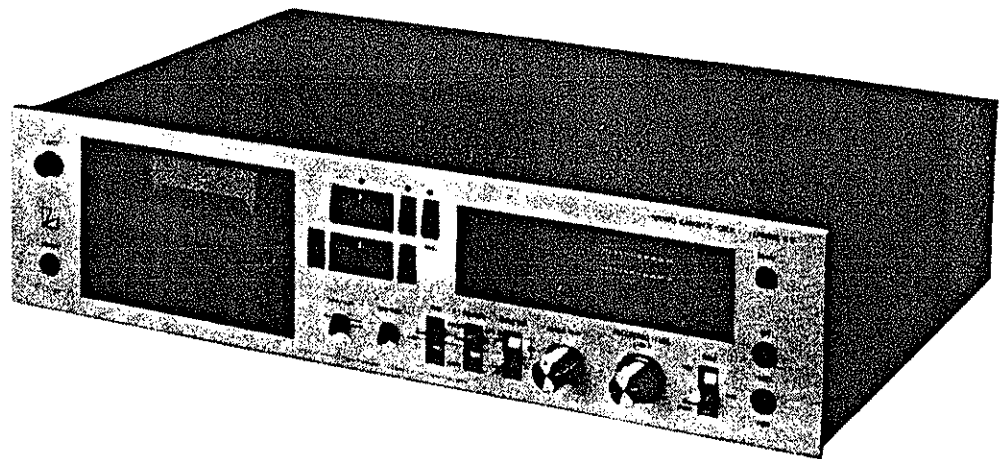

K- Adjustment Procedure

Step	Mode	Adjusting Point	Test Point	Connection	Remarks
1 Head azimuth adjustment	Playback Equalizer: NOR Dolby: OFF	"A" screw	LINE OUT	Fig.3	Tape: MTT-114 TP output: Max.
2 Playback output adjustment	Playback Equalizer: NOR Dolby: OFF	VR101 VR102	DOLBY IC No. 7 pin	Fig.3	Tape: MTT-150 TP output: 580mV
3 Input adjustment (REC/MONITOR)	Record Equalizer: METAL Dolby: OFF	VR1-1 VR1-2 (REC VR)	DOLBY IC No. 7 pin	Fig.4	Input: 400 Hz, 300 mV TP output: 580 mV
4 FL meter adjustment	Record Equalizer: METAL Dolby: OFF	VR107 VR108 VR109 VR110	Meter display	Fig.4	In the state thus achieved in Step 3, adjust VR107 and VR108 so that the meter will light up at 0 dB; adjust VR109 and VR110 so that the meter will light up at 20 dB.
5 Recording current adjustment	Record Equalizer: METAL Dolby: OFF Bias: Cut off	VR103 VR104	T.P. 1 T.P. 1'	Fig.4	Input: 400 Hz, 300 mV TP output: 0.9 mV Cut off bias at point B.
6 Bias current adjustment	Record Bias: METAL Dolby: OFF	VR105 VR106	T.P. 1 T.P. 1'	Fig.4	Input: Nothing TP output: 13 mV Connect at Point B
7 Bias current readjustment	Rec/Play Bias: METAL Equalizer: METAL Dolby: OFF	VR105 VR106	DOLBY IC No. 7 pin	Fig.4	In the state thus achieved in Step 3, Input: Record/Playback -25dB 17 kHz 1 kHz Output: OK at 17 kHz = 1 kHz. Reduce Bias current if 17 kHz > 1 kHz. Increase bias current if 17 kHz < 1 kHz.
8 Recording current readjustment	Rec/Play Bias: METAL Equalizer: METAL Dolby: OFF	VR103 VR104	DOLBY IC No. 7 pin	Fig. 4	Record/Playback in the state thus achieved in Step 3. Output: OK at 580 mV. Reduce recording current if > 580 mV. Increase recording current if < 580 mV.

Head Azimuth Adjustment

- 1) Close the cassette door, and remove 2 set screws.
At this point, be careful not to drop the acryl door. (Fig. 1)

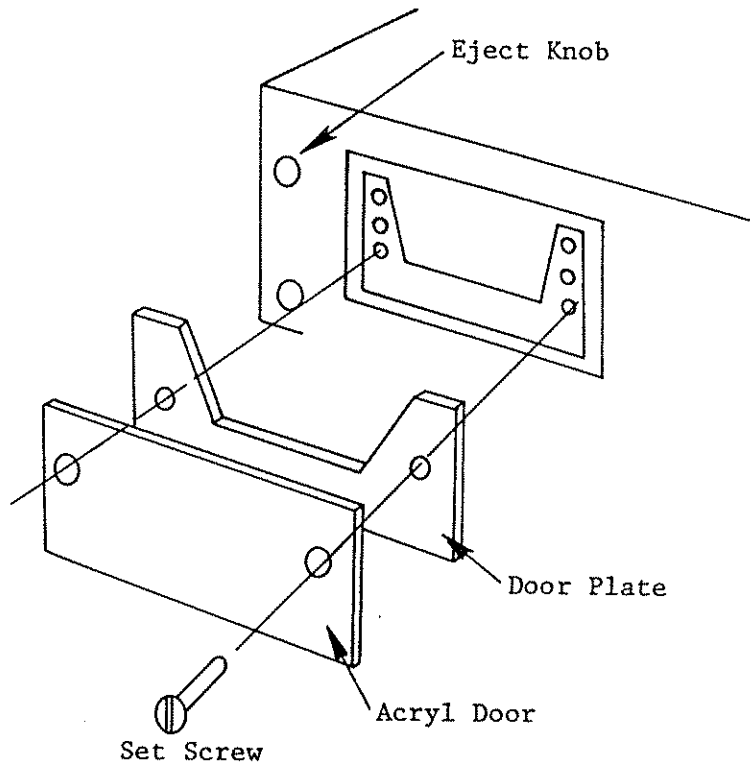

[Fig. 1]

- 2) When viewed from the front, the azimuth adjusting screw A can be seen under the door frame. (Fig. 2)

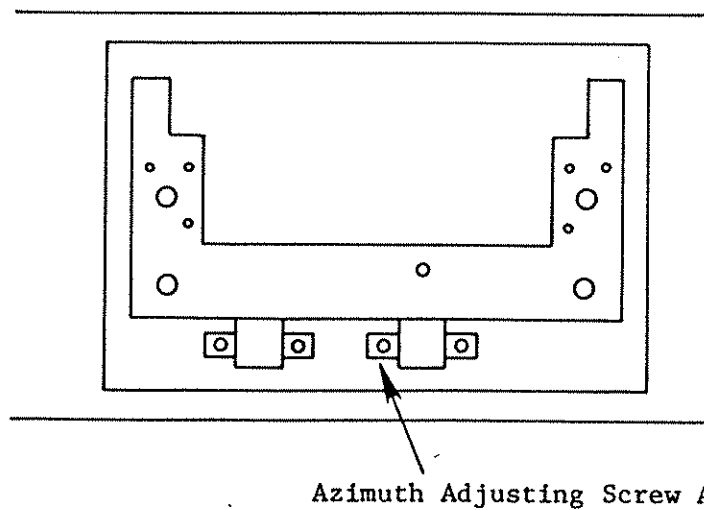

[Fig. 2]

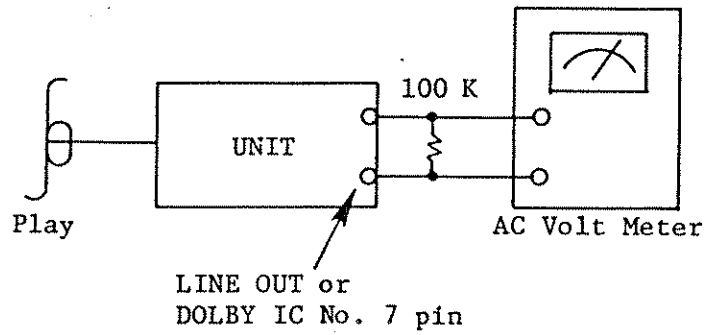

[Fig. 3]

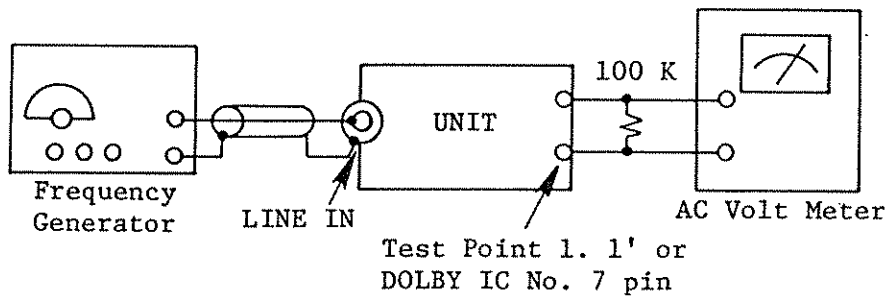

[Fig. 4]

[Location of M.B. Adjusting Point]

[Location of FL Meter Adjusting Point]

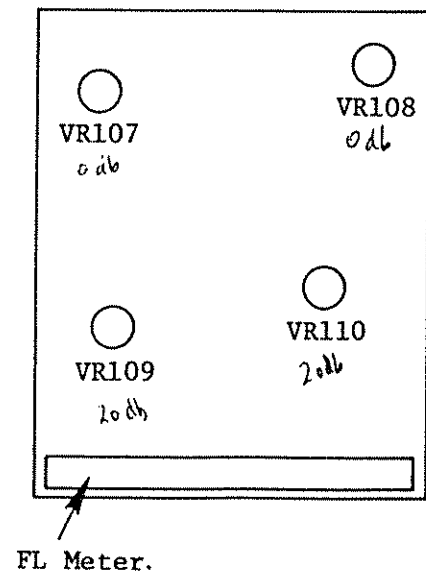
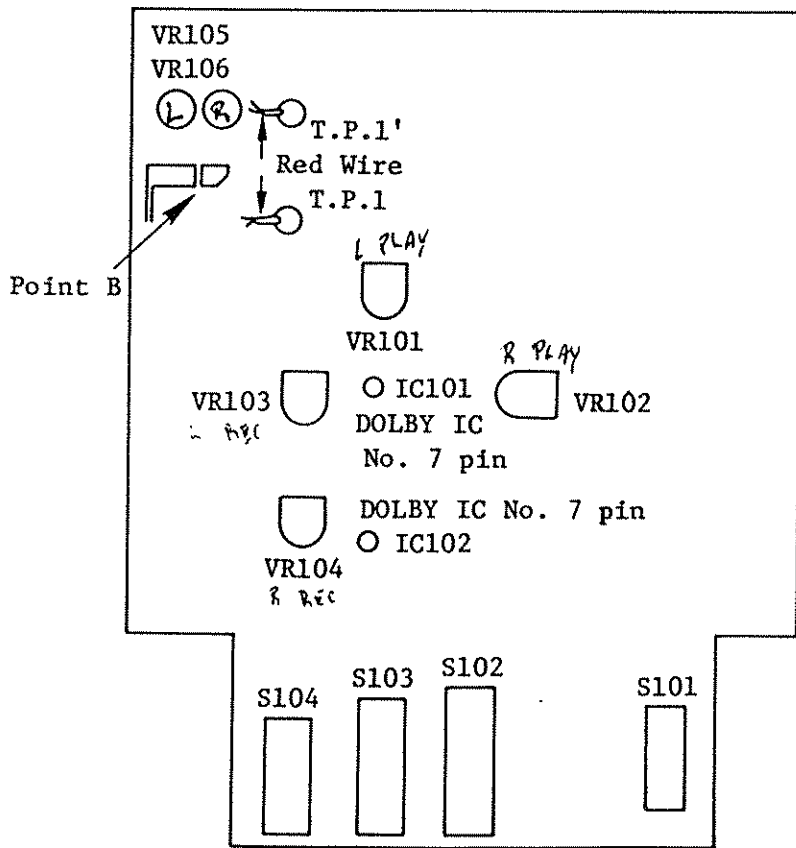

K-8 Level Diagram

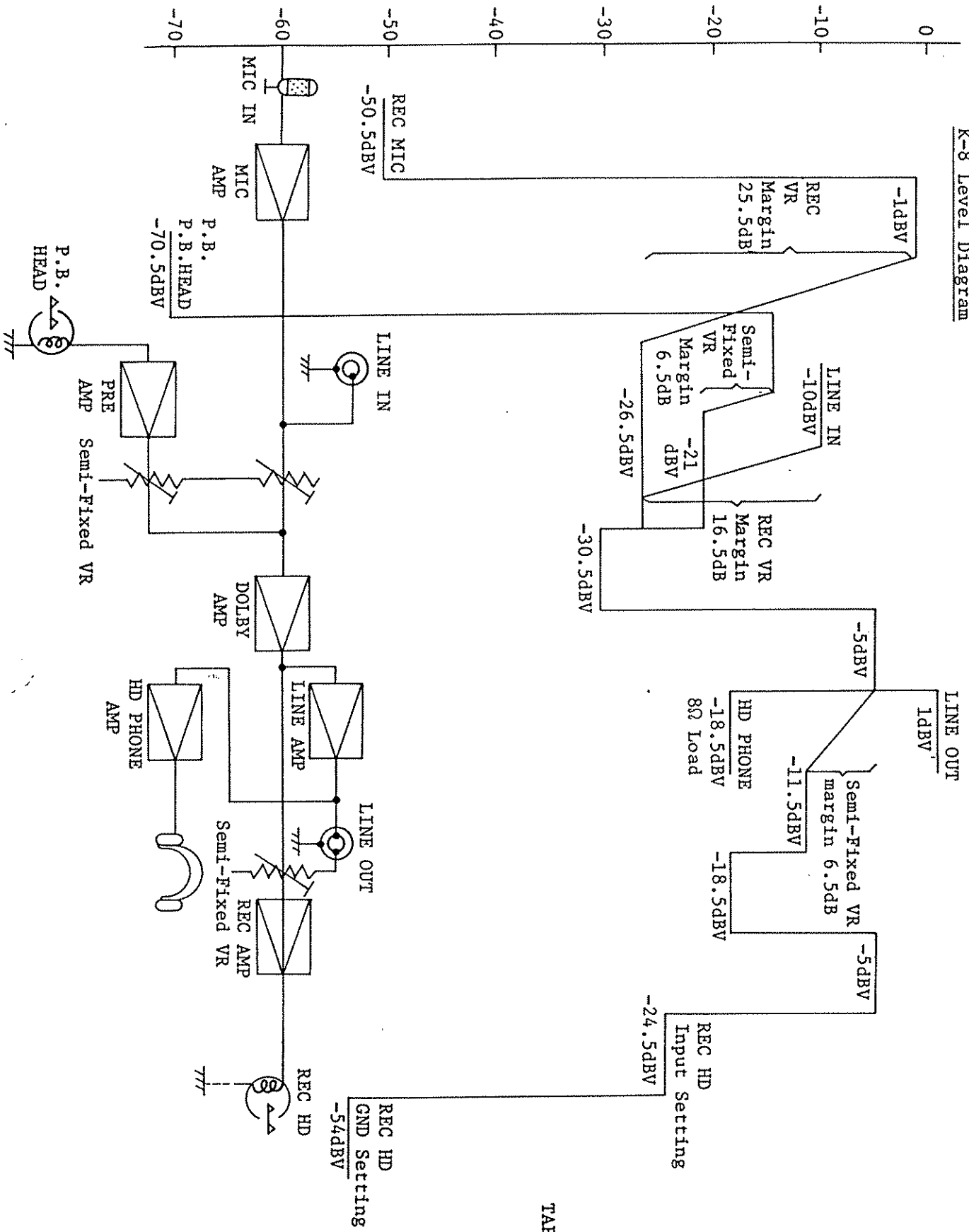

TAPE SELECT POSITION:
NORMAL

SYMBOL NO.	PART NUMBER	DESCRIPTION	QUANTITY PER UNIT
1	27C41765 F02	Chassis, Bottom	1
2	15D41766 F02	Cover Rear	1
3	43B41625 F02	Stopper Cord	1
4	3S40011 G06	Scr. Mch M2.6x6	2
5	3S44205 G05	Scr. Tpg M3x0.5x5	50
6	37S44468 G20	370 Tube UL	1
7	43A42519 F01	Spacer, Knob	1
8	43R43802 U01	Spacer, Knob 1066	1
9	7B41763 F02	Bkt., Sw. & VR.	1
10	29C41405 P03	Lug W. Around	2
11	7B41935 F01	Bkt., Mic Jack	1
12	3S44205 G03	Scr., Tap Tite M3x8	4
13	84D43044 F04	Panel, Mic Jack	1
14	7A41942 F01	Frame, Acryl Door	1
15	7C41760 F01	Bkt., Side R	1
16	7A43087 F01	Bkt., Trans	1
17	3S44205 G17	Scr. Blk M4x0.7x6	2
18	1V41800 F31	Assy., Master Board	1
19	3C42723 U01	Scr., Cup	4
20	1V41800 F34	Assy., FL Meter	1
21	3S40012 G26	Scr., Tpg M3x6	2
22	7A41940 F01	Bkt., Push Sw.	1
23	3S40018 G01	Scr., Tpg. M3x6	7
24	3S40012 G03	Scr., Tpg. M3x6	3
25	9A40961 P01	Holder Fuse	8
26	3S44205 G16	Scr., Tap Tite	7
27	1V41800 F39	Assy., Control Panel	1
28	1V41800 F38	Assy., Power Supply Panel	1
29	7A43683 U01	Bkt., Heat Sink	1
30	7B41939 F02	Bkt., FL Meter (R)	1
31	43A43182 P01	Spacer TR.	2
32	14A40472 G02	Insulator TR.	2
33	3A43146 G01	Scr., M2x0.4	2
34	3S40019 G23	Scr., F-Locks	4
35	7B41939 F01	Bkt., FL Meter (L)	1
36	7B41945 F01	Frame Counter	1
37	3S40012 G09	Scr., Tpg. M3x8	5
38	29C41045 P02	Lug Wrap Around	2
39	84C42065 F02	Panel, Etched Bias	1
40	7A41943 F01	Frame, Acryl Meter	1
41	7A41941 F01	Bkt., Power Sw.	1
42	3C40014 G04	Scr., Mch. M3x0.5	2
43	84C42065 F03	Panel, Etched Control	1
44	64A41950 F01	Plate, Acryl	1
45	26C41056 G02	Shield Mag Inside	2
46	26A42779 F01	Shield, Magnetic	1
47	7A40871 F01	Support, Trans	2
48	3S44205 G09	Scr., Tpg. M4x0.7	2
49	7A41758 F01	Bkt., DK	1
50	3S40011 G17	Scr., Mch. M3x0.5x6	2
51	5B41635 J02	Rivet Push	3
52	3C40014 G04	Scr., Mch. M3x0.5	10
53	84D41791 F03	Panel, 6 Keys	1
54	4S40072 G16	Wsr., T.L. M3	2
55	26A42518 F01	Shield, Mic Jack	1

SYMBOL NO.	PART NUMBER	DESCRIPTION	QUANTITY PER UNIT
56	64D41951 F01	Panel Front	1
57	26A42517 F01	Shield, Power Sw.	1
58	36R42690 F01	Knob, Push 1074	2
59	7B41938 F01	Bkt., Sw & Volume	1
60	84B43853 U01	Panel, Etched Power	1
61	84D41791 F06	Panel, Etched Bias	1
62	7R42019 F01	Frame, Lever Knob	4
63	37S44468 G15	380 Tube UL CSA	1
64	84D43044 F03	Panel, HP Jack	1
65	7B41936 F01	Bkt., HP Jack	1
66	36R42018 F02	Knob, Lever	4
67	36R43799 U01	Knob, Power 1089	1
68	36A42023 F01	Knob, Eject	1
69	36R43801 U01	Knob, Control 1077	2
70	7A43780 U01	Bkt., Side	4
71	64A41949 F01	Plate, Door	1
72	1U42000 F60	FH87E01A CAS T/D	1
73	7C41944 F01	Frame, Meter	1
74	3A41952 F01	Scr., Special	2
75	4A41014 U01	Washer Rabber	2
76	36C41948 F01	Knob, Logic Control	1
77	36R42021 F01	Knob, Control R	1
78	36R42022 F01	Knob, Control	2
79	15C41759 F01	Cover, Bottom	1
80	75A43532 P01	Pad Trannleg	4
81	15D41953 F01	Cover, Top	1
82	3S40036 U01	Scr., Tap Tite Blk	4
83	7B44494 P01	Shield OSC	1
84	75A44632 G04	Pad Cushion	3
85	3S40019 G31	Scr. F-Locks	2

Panel Etched Power



Panel Mic Jack

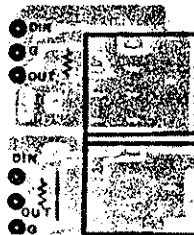

Panel HP Jack

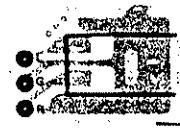

Panel Etched Control

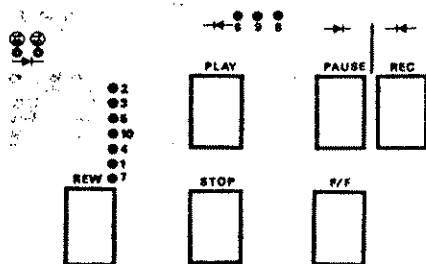

Panel Etched Bias



(II)

SYMBOL NO.	PART NUMBER	DESCRIPTION	QUANTITY PER UNIT
1	41T42885 F01	Spring, Sub Chas	1
2	1T42791 F01	Assy., Rivet Head Base	1
3	41T42852 F01	Spring, Head Base	1
4	41T42861 F01	Spring, Azimuth	2
5	29T42902 F01	Lug, Cord Clamp	3
6	41T42905 F01	Spring, Head Pull -B	1
7	41T42906 F01	Spring, Eject Sate. Arm	2
8	1T42795 F01	Assy., Riv. Sol. Lever	1
9	45T42803 F01	Arm, Solenoid	1
10	1T42794 F01	Assy., Riv. Shift Lever	1
11	45T42836 F01	Arm, HD. Chas Lock	1
12	41T42856 F01	Spring, Shift Lever	1
13	41T42855 F01	Spring, Stopper Arm	1
14	41T42896 F01	Spring, RC Lever	1
15	1T42796 F01	Assy., Riv, Sub Chas	1
16	4A43020 G12	Washer	2
17	41A43562 F01	Spring, Back T	2
18	1T42824 F01	Assy., Supply Reel	1
19	1T42825 F01	Assy., Take up Reel	1
20	64T42903 F01	Plate, Reflector	1
21	45T42812 F01	Arm, F-R Lock	1
22	1T42829 F01	Assy., Riv. FF Arm	1
23	1T42828 F01	Assy., Riv. Rew Arm	1
24	41T42904 F01	Spring, Idler	2
25	1T42826 F01	Assy., Pulley Arm	1
26	41T42905 F01	Spring, HD Pull -B	1
27	1T42827 F01	Assy., Riv. FF-Idl. Plt	1
28	49T42834 F01	Idler, Center	2
29	4S40075 G08	Washer, S T W	2
30	45T42804 F01	Lever, Brake	1
31	75T42864 F01	Pad, Brake	2
32	41T42895 F01	Spring, Lever	4
33	7T42893 F01	Bkt., Micro Sw	2
34	7A40675 T01	Bkt., Poise	2
35	41T42890 F01	Spring, Solenoid	2
36	84A42689 F01	Panel, Sensor	1
37	15A41630 F01	Cover, Sensor	1
38	7T42815 F01	Bkt., Photo Sensor	1
39	47T42891 F01	Plunger, Solenoid	2
40	22T42845 F01	Pin, Solenoid	2
41	45T42805 F01	Link, Plunger	2
42	7T42806 F01	Bkt., Motor	1
43	49T42846 F01	Pulley, Motor	1
44	75T42888 F01	Cushion, Motor	3
45	42T42889 F01	Ring, Motor	3
46	7T42814 F01	Bkt., Deck Panel	1
47	1T42830 F01	Assy., Riv. Fly. Bkt	1
48	3T42887 F01	Scr., Bearing	1
49	84B42688 F01	Panel, DK	1
50	1T42790 F01	Assy., Riv. Chas	1

65T41785F01

SYMBOL NO.	PART NUMBER	DESCRIPTION	QUANTITY PER UNIT
51	15T42865 F01	Housing, Capstan	1
52	45T42837 F01	Arm, Shift	1
53	45T42879 F01	Arm, Stopper	1
54	45T42802 F01	Arm, Play	1
55	1T42793 F01	Assy., Riv. P-Idl Lever	1
56	41T42881 F01	Spring, Cam	1
57	15T42842 F01	Holder, Ball	3
58	43T42882 F01	Bush, Rubber	1
59	1T42820 F01	Assy., Riv Case, Arm-L	1
60	1T42823 F01	Assy., Riv Case, Arm-R	1
61	45T42835 F01	Arm, Play Idler	1
62	41T42883 F01	Spring, Ball	1
63	1T42792 F01	Assy., Pinchroller	1
64	41T42853 F01	Spring, Pinchroller	1
65	47T42847 F01	Rod, Motor	1
66	44T42843 F01	Gear, Shift	1
67	41T42801 F01	Spring, Reset	1
68	49T42866 F01	Flywheel	1
69	42T42862 F01	Belt, Main	1
70	42T42863 F01	Belt, Sub	1
71	3C40014 G05	Scr., Mch. M3x5	4
72	45T42884 F01	Arm, Rec, Safety	2
73	4742844 F01	Saft, Rec, Arm	2
74	4C42091 G11	Washer C	12
75	43A44303 P01	Washer Oil Shiel	1
76	3C40014 G07	Mch, Scr, M2x0.4	2
77	3S40019 G06	Scr. M2x0.4x6	2
78	4C42091 G05	Washer C	14
79	15T42839 F01	Holder, Cas-L	1
80	4A41345 P02	Washer	2
81	4C42091 G06	Washer C	5
82	4C42091 G04	Washer C	4
83	4S40075 G12	Washer 3.1x5.4	1
84	4A41345 P06	Washer Lock	2
85	3C40014 G02	Mch, Scr. M2x0.4	1
86	3S40019 G17	Scr. M2.3x0.4x10	4
87	3S40019 G29	Scr. F-Lock	4
88	3C40121 T06	Scr. Mch. CW/DOU	3
89	15T42840 F01	Holder, Cas-R	1
90	3S44205 G12	Scr, T M3x4	11
91	3S44205 G03	Scr. Tap Tite M3x8	3
92	4C42091 G03	Washer C	1
93	3S44205 G01	Scr. Tpg M3x0.5x6	1
94	3C40014 G19	Scr. Mch. M2.6x5	1
95	3S40011 G88	Scr. Mch. M3x0.5x5	1
96	4S40075 G09	Washer S T W	1
97	3S40036 U03	Scr. Tap Tite	2
98	1T42797 F01	Assy., Riv. Sol. Bkt	1
99	1T42798 F01	Assy., Riv. Dumper Link	1
100	44B40208 T01	Gear, Drive	1
101	44B40207 T01	Gear, Driven	1
102	4A41345 P01	Washer Lock	2
103	30S43803 G05	Dial Cord	1
104	41T42854 F01	Spring, Hook	1
105	5A44852 G08	Eyelett	1

SYMBOL NO.	PART NUMBER	DESCRIPTION	QUANTITY PER UNIT
106	41B41492 U04	Spring, Pull	1
107	1T42799 F01	Assy., Riv. Case Bkt-L	1
108	95T42807 F01	Lever, Eject	1
109	64T42811 F01	Plate, Case Lock	1
110	45T42838 F01	Arm, Eject	1
111	47T42849 F01	Shaft, Eject Arm	1
112	1T42822 F01	Assy., Riv Cas Bkt-R	1
113	15T42817 F01	Case, Case-A	1
114	43A44303 P02	Washer, Oil Shiel	1
115	4S40075 G11	Washer, S T W	1
116	41T42808 F01	Spring, Cas-A	2
117	3S40011 G65	Mch., Scr. M3x0.5x4	4
118	43T42850 F01	Coller, Door	2
119	3S44205 G34	Scr., Tap Tite	2
120	41T42807 F01	Spring, Cas-B	1
121	3C40014 G07	Mch., Scr. M2x0.4	1
122	1T42989 F01	Assy., Riv. Tray	1
123	61T42841 F01	Lens Lamp	1
124	7T42833 F01	Guide, Cas.	2
125	3S44205 G29	Scr., Tap Tite	2
126	45T42810 F01	Arm, Eject Safety	1
127	43T42851 F01	Coller, Arm	1
128	Not Used		
129	43A41122 P01	Ball - Steel 2	4
130	47T42848 F01	Red, Panel - A	1
131	3S44205 G05	Scr., Taping M3x0.5x5	1
132	41T42860 F01	Spring, Clamp	1
133	43A43759 F01	Spacer, Head	1
134	4S40075 G05	Washer, 2.1x4x0.13	2
135	30B44668 J12	C.W. Shield Brn.	1
136	30B44668 J13	C.W. Shield Gry.	1
137	30T43888 U08	C.W. Shield Blk.	1
138	75A44238 P01	Pad Brake	1
E5	88T40191 F01	Head, R/P	1
E6	88T43875 U01	Head, Erase Sen alloy	1
E2	80T43863 F01	Solenoid	1
E3	80T43863 F02	Solenoid	1
M1	59T40783 T01	Motor	1
LD104	48T41632 F01	L. E. D	1
	48T41633 F01	Tr., Photo	1
D213, 214	48C40235 G01	Diode 10E1	2
S3, 6	40C40349 J02	Sw., Micro	2
R163	6S44593 P63	Res., FC 820	1
R162	6S44593 P73	Res., FC 2.2K	1
L101	65C42544 U02	Lamp Pilot	1

Panel Sensor



Panel DK

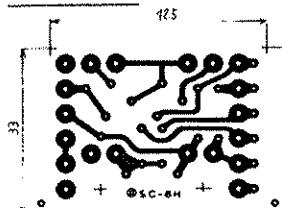

SYMBOL NO.	PART NUMBER	DESCRIPTION	QUANTITY PER UNIT
	84D43044 F01	Panel, Etched Master Board	1
IC105	51T40676 F01	IC, AN6551	1
IC101, 102	51T40114 T01	NE 645B	2
Q101, 102	48S40929 P01	Transister 2SC1222	2
Q105, 106	48S40929 P01	"	2
Q103, 104	48S40149 P01	TR, 2SC900E	2
Q107, 108	48S40149 P01	"	2
Q109, 110	48S40149 P01	"	2
Q111, 112	48S40149 P01	"	2
Q113, 114	48S40149 P01	"	2
Q119, 120	48S40149 P01	"	2
Q121, 122	48S40149 P01	"	2
Q123, 124	48S40149 P01	"	2
Q125, 126	48S40149 P01	"	2
Q127, 128	48S40149 P01	"	2
Q140	48S40149 P01	"	1
or	48S40246 G01	TR, 2SC732 BL	21
Q129, 130	48T40832 F03	TR, 2SC1318NC-R	2
Q116, 117	48S43239 G02	TR, 2SC509	2
Q135, 136	48T43394 P01	TR, 2SC1890	2
Q137, 138	48T43394 P01	"	2
Q139	48T40081 T03	TR, 2SA733 BL	1
E8, 9	51T42537 U01	MPX, Filter	2
R211, 212	6D40801 G55	Res., F.C. 470-1/2W	2
R213, 214	6S44593 P65	Res., F.C. 1K	2
R215, 216	6S44593 P65	"	2
R179, 180	6S44594 P20	Res., F.C. 180K	2
R231, 232	6S44593 P35	Res., F.C. 56	2
R105, 106	6S44593 P41	Res., F.C. 100	2
R129, 130	6S44593 P17	Res., F.C. 10	2
R163, 164	6S44593 P41	Res., F.C. 100	2
R209, 210	6S44593 P41	"	2
R303, 304	6S44593 P44	Res., F.C. 130	2
R329, 330	6S44593 P41	Res., F.C. 100	2
R113, 114	6S44593 P45	Res., F.C. 150	2
R143, 144	6S44593 P45	"	2
R191, 192	6S44593 P47	Res., F.C. 180-1/4	2
R309, 310	6S44593 P47	"	2
R291, 292	6S44593 P49	Res., F.C. 220	2
R223, 224	6S44593 P53	Res., F.C. 330	2
R225, 226	6S44593 P53	Res., F.C. 330	2
R227, 228	6S44593 P53	"	2
R309, 310	6S44593 P53	"	2
R147, 148	6S44593 P63	Res., F.C. 820	2
R117, 118	6S44593 P65	Res., F.C. 1K	2
R219, 220	6S44593 P65	"	2
R269, 270	6S44593 P65	"	2
R272	6S44593 P65	"	1

SYMBOL NO.	PART NUMBER	DESCRIPTION	QUANTITY PER UNIT
R155, 156	6S44593 P73	Res., F.C. 22K	2
R159, 160	6S44593 P77	Res., F.C. 3.3K	2
R187 188	6S44593 P77	"	2
R312	6S44593 P77	"	1
R289, 290	6S44593 P81	Res., F.C. 4.7K	2
R317, 319	6S44593 P81	"	2
R305, 306	6S44593 P97	Res., F.C. 22K	2
R115, 116	6S44593 P85	Res., F.C. 6.8K	2
R157, 158	6S44593 P86	Res., F.C. 7.5K	2
R101, 102	6S44593 P87	Res., F.C. 8.2K	2
R121, 122	6S44593 P87	"	2
R197, 198	6S44593 P88	Res., F.C. 91K-1/4	2
R139, 140	6S44593 P89	Res., F.C. 10K	2
R141, 142	6S44593 P89	Res., F.C. 10K	2
R199, 200	6S44593 P89	"	2
R229, 230	6S44593 P89	"	2
R103, 104	6S44593 P89	"	2
R263, 264	6S44593 P89	"	2
R277, 278	6S44593 P89	"	2
R285, 286	6S44593 P89	"	2
R333, 334	6S44593 P89	"	2
R313	6S44593 P89	"	1
R316, 318	6S44593 P89	"	2
R333, 334	6S44593 P89	"	2
R307, 308	6S44593 P91	Res., F.C. 12K	2
R149, 150	6S44593 P92	Res., F.C. 13K	2
R145, 146	6S44593 P93	Res., F.C. 15K	2
R281, 282	6S44593 P93	"	2
R283, 284	6S44593 P93	"	2
R301, 302	6S44593 P93	"	2
R151, 152	6S44593 P95	Res., F.C. 18K	2
R195, 196	6S44593 P95	"	2
R315	6S44593 P97	Res., F.C. 22K	1
R267, 268	6S44593 P98	Res., F.C. 24K	2
R261, 262	6S44593 P98	"	2
R325, 326	6S44593 P99	Res., F.C. 27K	2
R177, 178	6S44593 P99	"	2
R109, 110	6S44594 P04	Res., F.C. 39K	2
R135, 136	6S44594 P04	"	2
R167, 168	6S44594 P06	Res., F.C. 47K	2
R169, 170	6S44594 P06	"	2
R175, 176	6S44594 P06	"	2
R189, 190	6S44594 P06	"	2
R217, 218	6S44594 P06	"	2
R287, 288	6S44594 P06	"	2
R299, 300	6S44594 P06	"	2
R314, 360	6S44594 P06	"	2
R107, 108	6S44594 P08	Res., F.C. 56K	2
R133, 134	6S44594 P08	"	2
R265, 266	6S44594 P08	"	2
R203, 204	6S44594 P11	Res., F.C. 75K	2
R165, 166	6S44594 P14	Res., F.C. 100K	2
R171, 172	6S44594 P14	"	2
R173, 174	6S44594 P14	"	2

SYMBOL NO.	PART NUMBER	DESCRIPTION	QUANTITY PER UNIT
R161, 162	6S44594 P18	Res., F.C. 150K	2
R119, 120	6S44594 P07	Res., F.C. 62K	2
R273, 274	6S44594 P22	Res., F.C. 220K	2
R275, 276	6S44594 P22	"	2
R137, 138	6S44594 P23	Res., F.C. 240K	2
R183, 184	6S44594 P24	Res., F.C. 270K	2
R207, 208	6S44594 P28	Res., F.C. 390K	2
R123, 124	6S44594 P30	Res., F.C. 470K	2
R153, 154	6S44594 P40	Res., F.C. 1.2M	2
R193, 194	6S44594 P38	Res., F.C. 1M	2
R111, 112	6S44594 P46	Res., F.C. 2.2M	2
R363, 364	6S44594 P46	"	2
R362	6S44594 P50	Res., F.C. 3.3M-1/4W	1
R327	6D40801 G27	Res., F.C. 33-1/2W	1
R323	6C44652 G23	Res., Metal 150-1W	1
R331	6D40801 G51	Res., F.C. 330-1/2W	1
R271	6D40801 G55	Res., F.C. 470-1/2W	1
R321	6D40801 G49	Res., F.C. 270-1/2W	1
R205, 206	6D40801 G63	Res., F.C. 10K-1/2W	2
C107, 108	8S44505 P25	Cap., Cer. H 33pF	2
C123, 124	8S44505 P29	Cap., Cer. H 47pF	2
C231, 232	8S44505 P31	Cap., Cer. H 56pF	2
C179, 180	8S44505 P33	Cap., Cer. 68-50V	2
C217, 218	8S44505 P35	Cap., Cer. H 82pF	2
C219, 220	8S44505 P35	"	2
C133, 134	8S44505 P41	Cap., Cer. H 220pF	2
C135, 136	8S44505 P41	"	2
C229, 228	8T42081 U45	Cap., Polyethlen	1
C105, 106	8S44505 P45	Cap., Cer. H 470pF	2
C121, 122	8S44505 P45	"	2
C115, 116	8S44505 P44	Cap., Cer. H 390pF	2
C129, 130	8S40656 F08	Cap., Myler 0.0039μF	2
C147, 148	8S40656 F09	Cap., Myler 0.0047μF	2
C151, 152	8S40656 F10	Cap., Myler 0.0056μF	2
C209, 210	8S40656 F13	Cap., Myler 0.010μF	2
C203, 204	8S40656 F13	"	2
C207, 208	8S40656 F15	Cap., Myler 0.015μF	2
C211, 213	8S40656 F15	Cap., Myler 0.015μF	2
C214, 215	8S40656 F15	"	2
C216	8S40656 F15	"	1
C212	2S44503 P15	Cap., Myler 0.015μF 50V	1
C226	8S40656 F16	Cap., Myler 0.018μF	1
C224, 225	8S40656 F16	"	2
C153, 154	8S40656 F18	Cap., Myler 0.027μF	2
C141, 142	8S40656 F21	Cap., Myler 0.047μF	2
C161, 162	8S40656 F25	Cap., Myler 0.10μF	2
C173, 174	8S40656 F25	"	2
C159, 160	23T40475 U03	Cap., Ely. 0.33μF 50V	2
C103, 104	23S40657 F27	Cap., Ely. 0.47μF 50V	2
C195, 196	23D44333 G01	Cap., Ely. 1μF 50V	2
C131, 132	23S40657 F28	Cap., Ely. 1μF 50V	2
C119, 120	23S40657 F16	Cap., Ely. 47μF 25V	2
C169, 170	23S40657 F16	"	2
C173, 174	23S40657 F16	"	2
C227	23S40657 F16	"	1
C199, 200	23S40657 F16	"	2

SYMBOL NO.	PART NUMBER	DESCRIPTION	QUANTITY PER UNIT
C163, 164	23D44333 G08	Cap., Ely. 10μF 16V	2
C101, 102	23S40657 F10	Cap., Ely. 10μF 16V	2
C117, 118	23S40657 F10	"	2
C137, 138	23S40657 F10	"	2
C139, 140	23S40657 F10	"	2
C143, 144	23S40657 F10	"	2
C149, 150	23S40657 F10	"	2
C165, 166	23S40657 F10	"	2
C167, 168	23S40657 F10	"	2
C239	23D44333 G09	Cap., Ely. 10μF 25V	1
C125, 126	23S40657 F17	Cap., Ely. 10μF 25V	2
C171, 172	23S40657 F17	"	2
C240	23S40657 F17	"	1
C111	23D44333 G26	Cap., Ely. 47μF 25V	1
C109, 110	23S40657 F07	Cap., Ely. 47μF 10V	2
C127	23D44333 G30	Cap., Ely. 100μF 10V	1
C128	23S40657 F08	Cap., Ely. 100μF 10V	1
C197, 241	23S41198 U35	Cap., Min. 100μF 25V	2
C201, 202	23S40657 F12	Cap., Ely. 33μF 16V	2
C155, 156	23S41198 U41	Cap., Min. 220μF 16V	2
C175, 176	23S41198 U41	"	2
C157, 158	23S41198 U55	Cap., Min. 470μF 10V	2
C223	23S41198 U42	Cap., Min. 220μF 25V	1
C230, 229	8S44505 P26	Cap., Cer. H 36pF	2
L101, 102	24S41448 F84	Coil, Lin. Radial 8200μH	2
L107, 108	24S41448 F79	Coil, Ind. Radial 3300μH	2
L105, 106	24S41448 F80	Coil, Ind. Radial 3900μH	2
L109, 110	24T44499 P01	Coil, Ind. 27MH	2
D101, 102	48S134816	Diode S1 1S1555	2
D103, 104	48S134816	"	1
S102, 3	40T42082 F01	SW., Lever 6C-3P	1
S104	40T42083 F01	SW., Lever 2C-3P	1
S101	40T42084 F01	SW., Lever 4C-3P	1
VR105, 106	18T43406 P01	Res., Variable 220KB- 1/2W	2
VR101, 102	18C42061 J15	Res., Variable 50K	2
VR103, 104	18C42061 J15	"	2
T101	25T43882 U01	Trans. OSC	1

Master Board

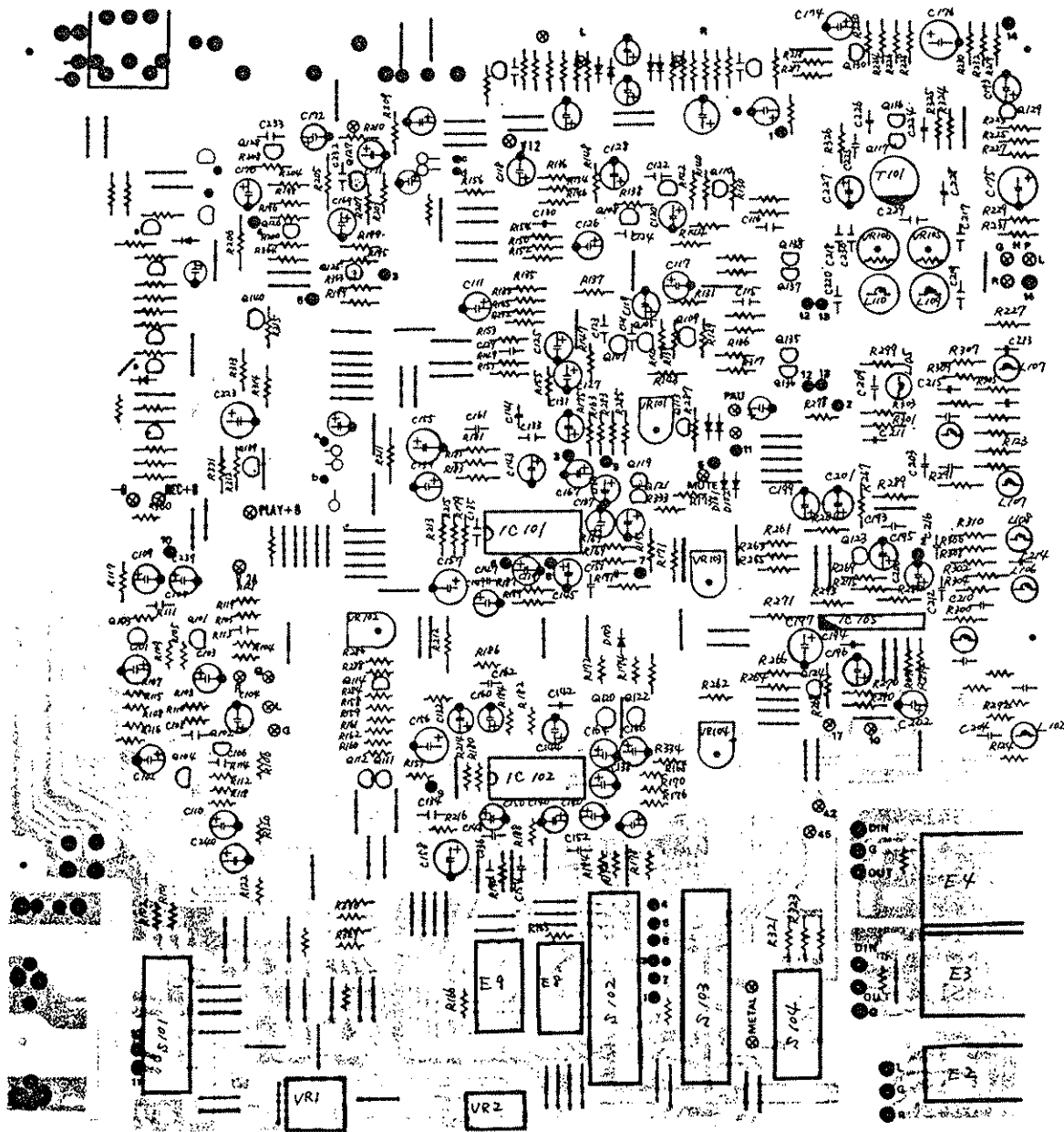

Assy., Packing

SYMBOL NO.	PART NUMBER	DESCRIPTION	QUANTITY PER UNIT
101	1V41800 F43	Assy., Panphlet	1
-1	56B40230 G21	Sack Poly.	1
-2	68R42057 F01	HD. Cleaning Tip.	1
-3	68P40880 F23	Owners, Manual	1
102	56B40442 T01	Packing Prent Frame	1
103	56C41779 F01	Tray, PKG	2
104	56C44246 U51	Carton, PKG	1
105	56A43711 F01	Tray, PKG	2
106	1V44200 J30	Assy., Kit	1
107 -1	28C42374 J02	Cord Output	2
-2	56B40230 G16	Sack Poly.	1

SYMBOL NO.	PART NUMBER	DESCRIPTION	QUANTITY PER UNIT
	84C42065 F01	Panel Etched FL-Meter	1/2
IC103, 104	51T42626 F01	IC. HA12019	2
VR107, 108	18C41732 G06	Res., Sc1 V. 10K-B	2
VR109, 110	18C41732 G06	"	2
V101, 102	48S44107 J01	Varistor	2
Q131, 132	48S40149 P01	TR2SC900E	2
Q133, 134	48S40149 P01	"	2
Q141, 142	48S40149 P01	"	2
D105, 106	48B41768 G01	Diode 1N60	2
D107, 108	48B41768 G01	"	2
ZD101	48T40059 U01	Zenner HZ6A-1L	1
or	48T40059 U02	Zenner HZ6A-2L	1
D109, 110	48S134816	Diode 1S1555	2
E7	65T44406 U01	F.L. Meter	1
R251, 252	6S40150 T48	Res., F.C. 200	2
R255, 256	6S40150 T08	Res., F.C. 56K	2
R243, 244	6S40150 T65	Res., F.C. 1K	2
R257, 258	6S40150 T89	Res., F.C. 10K	2
R253, 254	6S40151 T89	"	2
R247, 248	6S40151 T22	Res., F.C. 220K	2
R235, 236	6S40151 T46	Res., F.C. 2.2M	2
R239, 240	6S40150 T89	Res., F.C. 10K	2
R241, 242	6S40150 T57	Res., F.C. 470	2
R237, 238	6S40150 T75	Res., F.C. 2.7K	2
R259, 260	6S40150 T34	Res., F.C. 51	2
R328	6S44652 G08	Res., Metal Film 68-2W	1
C185, 186	23D44333 G01	Cap., Ely. 1 μ F 50V	2
C189, 190	23D44333 G05	Cap., Ely. 4.7 μ F 25V	2
C183, 184	23D44333 G05	Cap., Ely. 47 μ F 25V	2
C188	23D44333 G08	Cap., Ely. 10 μ F 16V	1
C181, 182	23D44333 G13	Cap., Ely. 22 μ F 16V	2
C233	23S41198 U57	Cap., Min. 470 μ F 25V	1
C177, 178	23D44333 G05	Cap., Ely. 4.7 μ F 25V	2
C179, 180	8S40154 T33	Cap., Cer. 68pF 50V	2
R233, 234	6S40150 T79	Res., F.C. 3.9K	2
R349, 350	6S40150 T79	"	2

Panel Etched FL-Meter

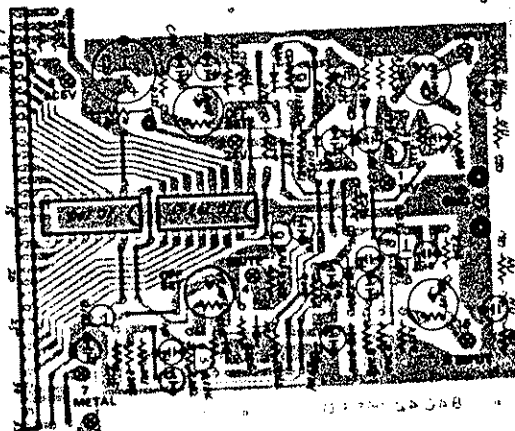

SYMBOL NO.	PART NUMBER	DESCRIPTION	QUANTITY PER UNIT
	84D41791 F01	Panel Power	1
Q125, 107	48T40081 T03	Transistor, 2SA733 BL	2
Q103, 105	48S40662 G05	TR., 2SD235 Y	2
Q106	48S40662 G05	TR., 2SD235 Y	1
Q124	48T40469 U01	TR., Silicon 2SC1983	1
Q108, 123	48S40149 P01	TR., 2SC900 E	2
Q126, 127	48S40149 P01	TR., 2SC900 E	2
Q104	48T41702 F04	TR., 2SD889	1
D201, 202	48C40235 G02	Diode 10E2	2
D203, 204	48C40235 G02	"	2
D205, 206	48C40235 G02	"	2
D207, 208	48C40235 G02	"	2
D209, 210	48C40235 G02	"	2
D211, 212	48C40235 G02	"	2
D101, 104	48S134816	Diode Si 1S1555	2
D107, 118	48S134816	"	2
D128, 129	48S134816	"	2
ZD102	48T40150 U61	Diode Zenner HZ12A-1	1
or	48T40150 U62	Diode Zenner HZ12A-2	1
ZD101	48T40150 U85	Diode Zenner HZ24-1	1
or	48T40150 U86	Diode Zenner HZ24-2	1
F104	65T42077 U09	Fuse, Semko (200MA)	1
F103	65T42077 U16	Fuse, Semko (1A)	1
F101, 102	65T42077 U17	Fuse, Semko (1.25A)	2
R156	6S44593 P41	Res., F.C. 100	1
R181	6S44593 P72	Res., F.C. 2K	1
R101	6S44593 P73	Res., F.C. 2.2K	1
R115, 150	6S44594 P14	Res., F.C. 100K	2
R159, 177	6S44594 P14	"	2
R109	6S44593 P85	Res., F.C. 6.8K	1
R178	6S44593 P89	Res., F.C. 10K	1
R116, 157	6S44593 P97	Res., F.C. 22K	2
R114	6S44593 P98	Res., F.C. 24K	1
R108, 112	6S44594 P02	Res., F.C. 33K	2
R123, 179	6S44594 P02	"	2
R113, 180	6S44594 P06	Res., F.C. 47K	2
R124, 158	6S44594 P08	Res., F.C. 56K	2
R125	6S44593 P99	Res., F.C. 27K	1
R110	6D40801 G53	Res., F.C. 390 1/2W	1
R102	6C43205 J25	Res., Metal Film 470 1/2W	
R183	6C44652 G10	Res., Metal Film 220 1W	
C118	23D44333 G05	Cap., Ely. 4.7 25V	1
C101	23S40657 F16	Cap., Ely. 4.7 25V	1
C131, 120	23S40657 F17	Cap., Ely 10 25V	2
C105	23S41198 U42	Cap., Min 220 25V	1
C119	23S41198 U57	Cap., Min 470 25V	1
C102, 106	23S40657 F14	Cap., Ely 100 16V	2
C108, 109	23S40657 F14	" "	2
C103	23S41198 U67	Cap., Min 1000 50V	1
C104	23S41198 U72	Cap., Min 2200 25V	1
C107	23S41198 U71	Cap., Min 2200 16V	1
C127	23S41198 U79	Cap., Min 4700 10V	1
C112	23S40654 F16	Cap., Tantal 2.2 μ F	1

Panel Power

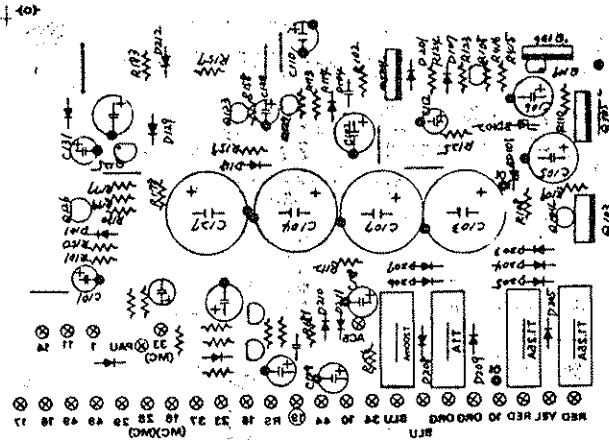

Assy., Control Panel

SYMBOL NO.	PART NUMBER	DESCRIPTION	QUANTITY PER UNIT
	84D41791 F02	Panel, Control	1
IC101	51T40471 U01	IC 9121P	1
D102, 106	48S134816	Diode Si 1S1555	2
D108, 109	48S134816	" 1S1555	2
D110, 111	48S134816	" 1S1555	2
D112, 116	48S134816	" 1S1555	2
D117, 119	48S134816	" 1S1555	2
D120, 121	48S134816	" 1S1555	2
D122, 124	48S134816	" 1S1555	2
D125, 126	48S134816	" 1S1555	2
D127, 137	48S134816	" 1S1555	2
D132	48S134816	" 1S1555	1
Q111, 112	48T40832 F04	TR., 2SC1318 NC-S	2
Q101, 109	48S40149 P01	TR., 2SC900 E	2
Q110, 113	48S40149 P01	" 2SC900 E	2
Q114, 116	48S40149 P01	" 2SC900 E	2
Q118, 119	48S40149 P01	" 2SC900 E	2
Q120, 121	48S40149 P01	" 2SC900 E	2
Q122, 128	48S40149 P01	" 2SC900 E	2
or	48T42943 U01	" 2SC1684	12
Q115, 117	48T40081 T03	TR., 2SA733 BL	2
R106	6S44593 P33	Res., F.C. 47	1
R103, 119	6S44593 P65	Res., F.C. 1K	2
R120, 122	6S44593 P65	" 1K	2
R121	6S44593 P72	Res., F.C. 2K	1
R165	6S44593 P76	Res., F.C. 3K	1
R185	6S41801 P36	Res., F.C. 2.2K 1/4	1
R127, 128	6S44593 P79	Res., F.C. 3.9K	2
R129, 130	6S44593 P79	" 3.9K	2
R184	6S41801 P43	Res., F.C. 8.2K 1/4	1

Panel Control

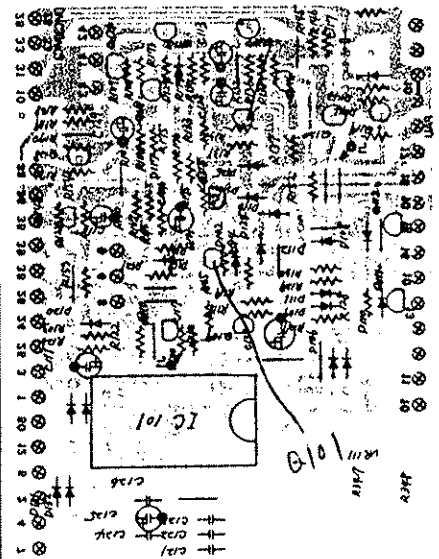

SYMBOL NO.	PART NUMBER	DESCRIPTION	QUANTITY PER UNIT
R104, 105	6S44593 P89	Res., F.C. 10K	2
R107, 117	6S44593 P89	" 10K	2
R131, 132	6S44593 P89	" 10K	2
R134, 136	6S44593 P89	" 10K	2
R137, 138	6S44593 P89	" 10K	2
R152, 160	6S44593 P89	" 10K	2
R161, 167	6S44593 P89	" 10K	2
R169, 170	6S44593 P89	" 10K	2
R171, 174	6S44593 P89	" 10K	2
R175	6S44593 P91	Res., F.C. 12K	1
R133, 153	6S44593 P97	Res., F.C. 22K	2
R154, 173	6S44593 P97	" 22K	2
R176	6S44593 P97	" 22K	1
R143, 144	6S44594 P06	Res., F.C. 47K	2
R145, 146	6S44594 P06	" 47K	2
R166, 168	6S44594 P06	" 47K	2
R172	6S44594 P08	Res., F.C. 56K	1
R126, 135	6S44594 P14	Res., F.C. 100K	2
R148, 164	6S44594 P14	" 100K	2
R118	6S44594 P22	Res., F.C. 220K	1
C121, 122	8S41442 F13	Cap., Mylar 0.010	2
C123, 124	8S41442 F13	" 0.010	2
C126	8S41442 F13	" 0.010	1
C114, 125	23C42909 J02	Cap., Ely 0.47	2
C111	23S40657 F28	Cap., Ely 1 50V	1
C128	23D44333 G05	Cap., Ely 4.7 25V	1
C130	23S41198 U34	Cap., Min 100 16V	1
C118	23S41059 P07	Cap., Tantal 1 35V	1
C113	23S40654 F27	Cap., Tantal 4.7	1
C129	23S40657 F10	Cap., Ely 10 16V	1

Missceraneous

SYMBOL NO.	PART NUMBER	DESCRIPTION	QUANTITY PER UNIT
P101	28T43849 U01	Plug AC Cord	1
S2	40T42063 F01	Sw. Rotary	1
S1	40B41998 P02	Sw. Power (SDG 5P-E)	1
S4, S5	40T42066 F01	Sw. Memory & Reset	1
S101 ~ 106	40T42904 U01	Sw. AKC8S	6
VR2	18T44715 P01	Resistor Variable	1
VR1	18T44716 P01	Resistor Variable	1
VR111	18T43904 U01	Vr. Rotary Bias	1
E2	9T40027 F01	Jack, HD Phone	1
E3, E4	9T40026 F01	Jack, Mic	2
E101	9T42751 F01	Din, Jack 8P	1
R348	6S44593 P58	Res., F.C. 510	1
R347	6S44593 P81	Res., F.C. 4.7K	1
C132, 133	8T43867 F01	Cap., MP 0.01	2
Q115	48T40832 F03	Tr. 2SC1318 NC-R	1

SYMBOL NO.	PART NUMBER	DESCRIPTION	QUANTITY PER UNIT
E4	65T41785 F01	Lamp F.L. Counter Ass	1
T101	25T42086 F01 25T42705 F01	Transformer Power	1
LD103, 105	48T40818 T01	LED T Run	2
LD101, 102	48T40818 T02	LED Grn	2
E1	9B44393 P01	Plate Phono	1

K-8 SPECIFICATIONS

Heads	2heads Record/Playback; Sendust(3-lay laminate d)×1 Erase; Sendust×1
Drive Motor	1motor(DC-servo type)
Tape Drive	Single Capstan
Operation System	Feather Touch Logic Control System
Wow & Flutler	no more than 0.055%(W .R.M.S.)
Amplifier	DC Amp Configuration(record amp.)
Signal-to-Noise	better than 58dB(Dolby off).....metal tape better than 65dB(Dolby on).....metal tape better than 57dB(Dolby off).....C.Oz tape better than 63dB(Dolby on).....C.Oz tape better than 55dB(Dolby off).....LH tape better than 60dB(Dolby on).....LH tape
Frequency Response	20Hz~20kHz(30Hz-17kHz±3dB)··metal tape 20Hz~18kHz(30Hz-16kHz±3dB)··C.Oz tape 20Hz~16kHz(30Hz-15kHz±3dB)··LH tape
Overall Distortion	no more than 1.5%(LH tape, 1kHz, 0dB)
Real Analyzed Distortion	no more than 0.7%(LH tape, 1kHz, 0dB)
Input Sensitivity	line in 100mV miC; 0.3mV(recommended microphone impedance; 600-10Kohms)
Output level	line in; IV headphone; 1.25W(8ohms load)
Additional Features	12-dot Fluorescent Peal Level Indicator, Fluorescent Tape Counter, Bias Fine Control, 3-position Bias/Equalizer Selector, Playback SKEW Adjustment Hole, REC. MUTE Function, Dolby NR System, Timer Recording/Playback Function, Autmatic Functions(Play, rewind, repeat), Remote Control (available with optional remote control box).
Power Consumption	30W
Dimensions	438(W)×285(D)×108(H)mm (17-1/4"×11-7/32"×4-1/4")
Weight	Net 6.0kgs (13.2 lbs) Gross 8.0kgs (17.6 lbs)

Specifications and appearance design subject change without notice.

NOISE REDUCTION CIRCUIT MADE UNDER LICENCE FROM DOLBY LABORATORIES. THE WORD "DOLBY" AND THE DOUBLE-D SYMBOL ARE THE TRADE MARKS OF DOLBY LABORATORIES.

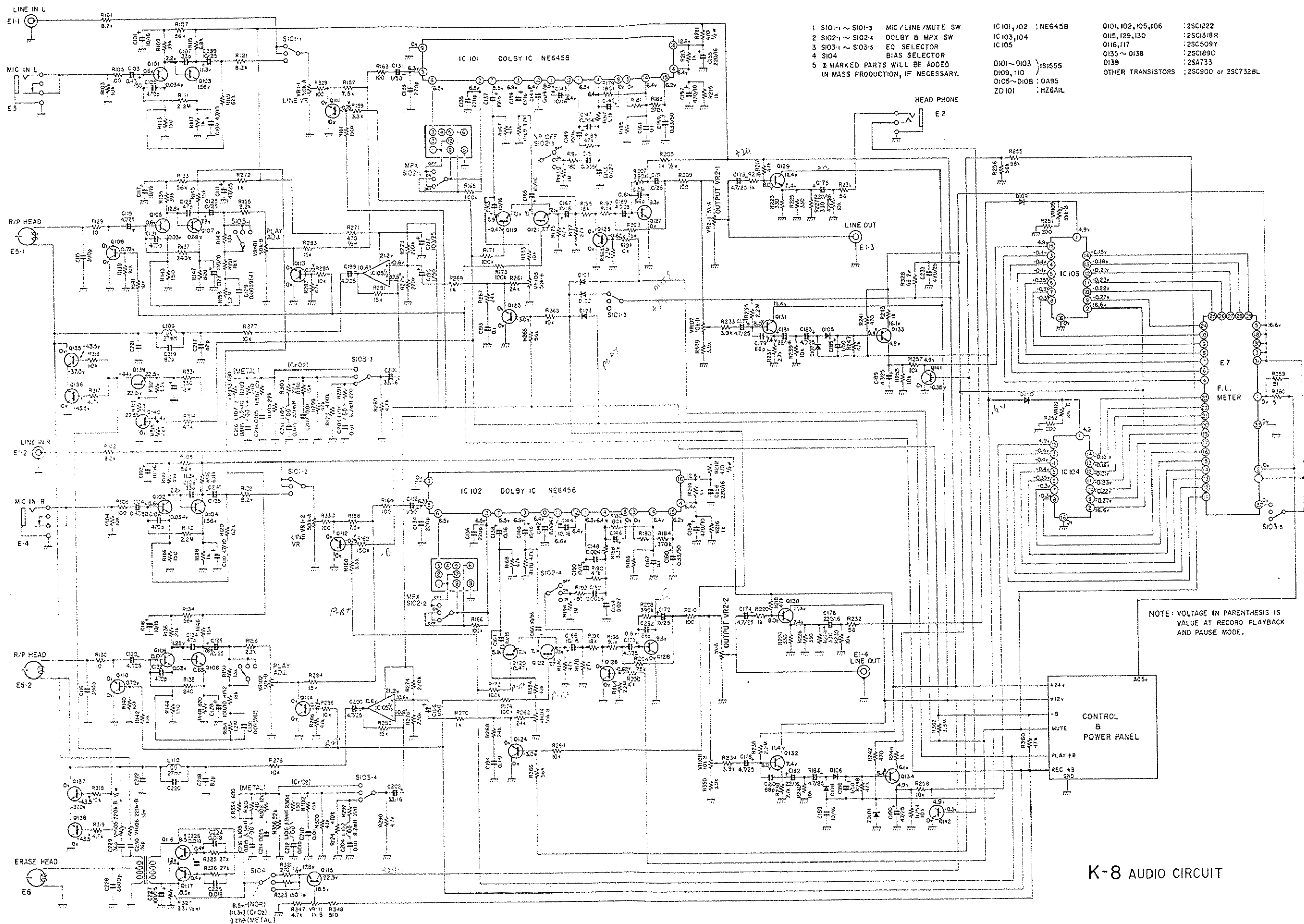

- 1 SIO1-1 ~ SIO1-3 MIC/LINE/MUTE SW
- 2 SIO2-1 ~ SIO2-4 DOLBY B MPX SW
- 3 SIO3-1 ~ SIO3-5 EQ SELECTOR
- 4 SIO4 BIAS SELECTOR
- 5 X MARKED PARTS WILL BE ADDED IN MASS PRODUCTION, IF NECESSARY.

- IC101,102 : NE6458
- IC103,104
- IC105
- D101~D103 : 1S1555
- D109,110
- D105~D108 : OA95
- ZD101 : HZ6A1L

- Q101,102,105,106 : 2SC1222
- Q115,129,130 : 2SC318R
- Q116,117 : 2SC509Y
- Q135~Q138 : 2SC1890
- Q139 : 2SA733
- OTHER TRANSISTORS : 2SC900 or 2SC732BL

NOTE: VOLTAGE IN PARENTHESIS IS VALUE AT RECORD PLAYBACK AND PAUSE MODE.

K-8 AUDIO CIRCUIT

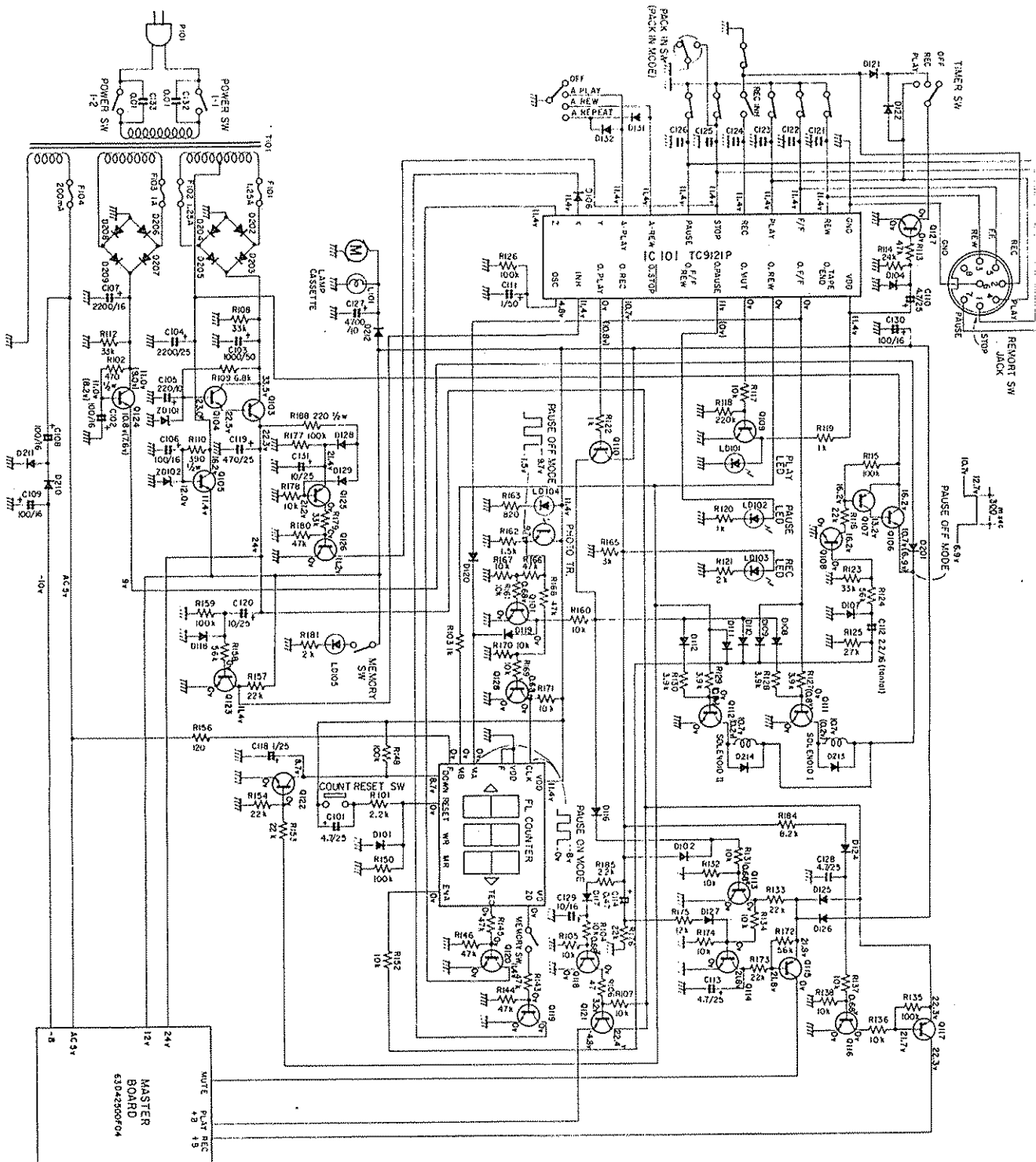

- Q13, Q105, Q106 25D235Y
- Q04 25D089
- D01, D08, D09, Q13, Q126, Q127 25C900E
- D10, Q13, Q14, Q16, Q18, Q19 25C900E
- D20, Q121, Q122, Q128 25C900E
- Q111, Q112 25C13181C-S
- Q124 25C1983
- Q125, Q107, Q115, Q117 25A1738L
- D201~D212 IOE 2
- D101, D104, D107, D118, D128, D129 1S1555
- D102, D106, D108~D112 1S1555
- D16~D121, D131, D132 1S1555
- ZD101 HZ-24-1
- ZD102 HZ124-1

NOTE: VOLTAGE IN PARENTHESIS IS VALUE AT RECORD PLAYBACK AND PAUSE MODE. () SHOWS PAUSE OFF MODE.

K-8 CONTROL & POWER SUPPLY

